

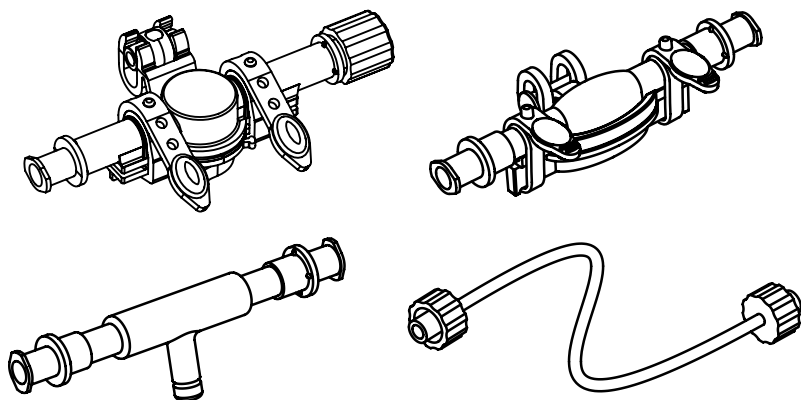

# Organ Recovery systems

## LifePort® Kidney Transporter Disposable Cannula



### Instructions for Use

Universal SealRing®, SealRing®, Straight, and Coupler are for use only with LifePort Kidney Transporter system.

 **Organ Recovery Systems, Inc.**  
One Pierce Place, Suite 475W  
Itasca, IL 60143  
USA

T +1.847.824.2600  
F +1.847.824.0234  
**Perfusion Helpline**  
+1.866.682.4800  
+1.352.721.5301

**Organ Recovery Systems NV**  
Culliganlaan 1B  
1831 Diegem  
Belgium

T +32.2.715.0000  
F +32.2.715.0009  
**Perfusion Helpline**  
+32.2.715.0005  
+33.967.23.00.16  
+49.69677.328.9966

## Universal SealRing

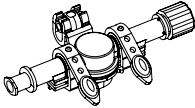

UCAN0003  
UCAN0005  
UCAN0007  
UCAN0009

### INDICATIONS FOR USE

LifePort Kidney Transporter (LKT) system is intended to be used for the continuous hypothermic machine perfusion of kidneys for the preservation, transportation, and eventual transplantation into a recipient.

### DEVICE DESCRIPTION

LifePort Kidney Transporter Disposable Universal SealRing Cannula is used when the vessel to be perfused ends with or without an aortic patch or similar condition.

The complete LifePort Kidney Transporter system is comprised of the following components:

- LifePort Kidney Transporter (LKT100P/LKT101P/LKT101PNG)
- LifePort Kidney Transporter Disposable Perfusion Circuit (LKT201/LKT201X)
- LifePort Kidney Transporter Disposable Sterile Drape (LKT300)
- LifePort Kidney Transporter Disposable Cannula (CAN/UCAN)

### INSTRUCTIONS FOR USE

Prepare LifePort Kidney Transporter and LifePort Kidney Transporter Perfusion Circuit as described in their Instructions for Use. If cannulating multiple vessels, refer to LifePort Kidney Transporter Disposable Coupler Instructions for Use.



**WARNING:** Perform the following procedure on an aseptic field using aseptic technique.

1. Introduce LifePort Kidney Transporter Disposable Universal SealRing Cannula onto the sterile field.
2. Open LifePort Kidney Transporter Disposable Universal SealRing Cannula by unhooking the straps, unsnapping, and opening the right anvil.
3. Position the vessel in the center of the anvils so the terminated end of the vessel is approximately 1.5–2.0mm above the top surface of the anvils.
4. Close the right anvil, capturing the vessel with an audible click.

**NOTE:** If necessary, retention stays can be added to the vessel using suture or other appropriate material. Suture Tie Down Cleats and slots have been provided to facilitate positioning.

5. Lower the upper portion of LifePort Kidney Transporter Disposable Universal SealRing Cannula while carefully bringing the conical seal into the interior of the vessel.

**NOTE:** Viewing through the magnified sight-glass, verify that the vessel orifice is centered, circular in shape and not occluded.

6. Wrap each strap around both cannula halves and secure the straps to their posts.
7. Place the kidney in the Kidney Cradle and snap LifePort Kidney Transporter Disposable Universal SealRing Cannula into the Cannula Mount.

**NOTE:** If perfusing multiple vessels, only the main vessel cannula shall be connected to the Cannula Mount.

8. Adjust the height of the Cannula Mount and rotation of the cannula to comfortably position the vessel.
9. Visually inspect the vessel, ensuring there are no twists or occlusions.
10. Secure the Mesh Organ Restraint over the kidney in the Kidney Cradle, allowing for slight swelling while being perfused.



**CONSULT INSTRUCTIONS FOR USE:** Follow the procedure in LifePort Kidney Transporter Disposable Perfusion Circuit Instructions for Use on how to place the kidney and Kidney Cradle within LifePort Kidney Transporter Disposable Perfusion Circuit.



**CONSULT INSTRUCTIONS FOR USE:** Follow the procedure outlined in LifePort Kidney Transporter Disposable Sterile Drape Instructions for Use to maintain aseptic conditions.



**CONSULT INSTRUCTIONS FOR USE:** Follow the procedure in LifePort Kidney Transporter Operator's Manual to start the perfusion process and check for leaks and bubbles.

## SealRing

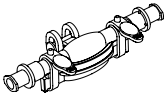

CAN0720  
CAN1035

### INDICATIONS FOR USE

LifePort Kidney Transporter (LKT) system is intended to be used for the continuous hypothermic machine perfusion of kidneys for the preservation, transportation, and eventual transplantation into a recipient.

### DEVICE DESCRIPTION

LifePort Kidney Transporter Disposable SealRing Cannula is used on explanted kidneys when the vessel to be perfused ends with an aortic patch or similar condition.

The complete LifePort Kidney Transporter system is comprised of the following components:

- LifePort Kidney Transporter (LKT100P/LKT101P/LKT101PNG)
- LifePort Kidney Transporter Disposable Perfusion Circuit (LKT201/LKT201X)
- LifePort Kidney Transporter Disposable Sterile Drape (LKT300)
- LifePort Kidney Transporter Disposable Cannula (CAN/UCAN)

### INSTRUCTIONS FOR USE

Prepare LifePort Kidney Transporter and LifePort Kidney Transporter Perfusion Circuit as described in their Instructions for Use. Patches that contain multiple arteries may be able to be placed into one LifePort Kidney Transporter Disposable SealRing Cannula. Otherwise, refer to LifePort Kidney Transporter Disposable Coupler Instructions for Use to cannulate multiple vessels.



**WARNING:** Where noted, perform the following procedure on an aseptic field using aseptic technique.

1. Introduce LifePort Kidney Transporter Disposable SealRing Cannula onto the sterile field.
2. Unhook the straps and open LifePort Kidney Transporter Disposable SealRing Cannula.
3. Slide the aortic patch through the center of the cannula ring.
4. Lay patch flat, making sure that the tissue covers the entire cannula ring. If necessary, instruments may be used to temporarily hold the tissue in place until LifePort Kidney Transporter Disposable SealRing Cannula is secure.
5. Close LifePort Kidney Transporter Disposable SealRing Cannula, securing the tissue between the two cannula halves.
6. Wrap each strap around both cannula halves and secure the straps to their posts.
7. Place the kidney in the Kidney Cradle and snap LifePort Kidney Transporter Disposable SealRing Cannula into the Cannula Mount.

**NOTE:** If perfusing multiple vessels, only the main vessel cannula shall be connected to the Cannula Mount.

8. Adjust the height of the Cannula Mount and rotation of the cannula to comfortably position the vessel.
9. Visually inspect the vessel, ensuring there are no twists or occlusions.
10. Secure the Mesh Organ Restraint over the kidney in the Kidney Cradle, allowing for slight swelling while being perfused.



**CONSULT INSTRUCTIONS FOR USE:** Follow the procedure in LifePort Kidney Transporter Disposable Perfusion Circuit Instructions for Use on how to place the kidney and Kidney Cradle within LifePort Kidney Transporter Disposable Perfusion Circuit.



**CONSULT INSTRUCTIONS FOR USE:** Follow the procedure outlined in LifePort Kidney Transporter Disposable Sterile Drape Instructions for Use to maintain aseptic conditions.



**CONSULT INSTRUCTIONS FOR USE:** Follow the procedure in LifePort Kidney Transporter Operator's Manual to start the perfusion process and check for leaks and bubbles.

## Straight

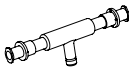

CAN0003  
CAN0005  
CAN0008

### INDICATIONS FOR USE

LifePort Kidney Transporter (LKT) system is intended to be used for the continuous hypothermic machine perfusion of kidneys for the preservation, transportation, and eventual transplantation into a recipient.

### DEVICE DESCRIPTION

LifePort Kidney Transporter Disposable Straight Cannula is used when the vessel to be perfused ends without a patch or when potential intimal lining damage is not a concern.

The complete LifePort Kidney Transporter system is comprised of the following components:

- LifePort Kidney Transporter (LKT 100P/LKT 101P/LKT 101PNG)
- LifePort Kidney Transporter Disposable Perfusion Circuit (LKT201/LKT201X)
- LifePort Kidney Transporter Disposable Sterile Drape (LKT300)
- LifePort Kidney Transporter Disposable Cannula (CAN/UCAN)

### INSTRUCTIONS FOR USE

Prepare LifePort Kidney Transporter and LifePort Kidney Transporter Perfusion Circuit as described in their Instructions for Use. If cannulating multiple vessels, refer to LifePort Kidney Transporter Disposable Coupler Instructions for Use.



**WARNING:** Perform the following procedure on an aseptic field using aseptic technique.

1. Introduce LifePort Kidney Transporter Disposable Straight Cannula onto the sterile field.
2. Insert LifePort Kidney Transporter Disposable Straight Cannula tip no further than necessary into the vessel. Minimizing the length of the cannula tip being inserted into the vessel will allow for resection of that segment of the vessel if necessary.
3. Secure the vessel in place using silk ties, vessel loops, or another appropriate material. A groove in the tip is provided for positioning and securing.
4. Place the kidney in the Kidney Cradle and snap LifePort Kidney Transporter Disposable Straight Cannula into the Cannula Mount.
5. Adjust the height of the Cannula Mount and rotation of the cannula to comfortably position the vessel.
6. Visually inspect the vessels and Coupler tubing, ensuring there are no twists or occlusions.
7. Secure the Mesh Organ Restraint over the kidney in the Kidney Cradle, allowing for slight swelling while being perfused.



**CONSULT INSTRUCTIONS FOR USE:** Follow the procedure in LifePort Kidney Transporter Disposable Perfusion Circuit Instructions for Use on how to place the kidney and Kidney Cradle within LifePort Kidney Transporter Disposable Perfusion Circuit.



**CONSULT INSTRUCTIONS FOR USE:** Follow the procedure outlined in LifePort Kidney Transporter Disposable Sterile Drape Instructions for Use to maintain aseptic conditions.



**CONSULT INSTRUCTIONS FOR USE:** Follow the procedure in LifePort Kidney Transporter Operator's Manual to start the perfusion process and check for leaks and bubbles.

## Coupler



CAN1000

### INDICATIONS FOR USE

LifePort Kidney Transporter (LKT) system is intended to be used for the continuous hypothermic machine perfusion of kidneys for the preservation, transportation, and eventual transplantation into a recipient.

### DEVICE DESCRIPTION

LifePort Kidney Transporter Disposable Coupler is used to connect two or more cannula when multiple vessels must be perfused.

The complete LifePort Kidney Transporter system is comprised of the following components:

- LifePort Kidney Transporter (LKT 100P/LKT 101P/LKT 101PNG)
- LifePort Kidney Transporter Disposable Perfusion Circuit (LKT201/LKT201X)
- LifePort Kidney Transporter Disposable Sterile Drape (LKT300)
- LifePort Kidney Transporter Disposable Cannula (CAN/UCAN)

### INSTRUCTIONS FOR USE

Prepare LifePort Kidney Transporter and LifePort Kidney Transporter Perfusion Circuit as described in their Instructions for Use.



**WARNING:** Perform the following procedure on an aseptic field using aseptic technique.

1. Introduce LifePort Kidney Transporter Disposable Coupler onto the sterile field.
2. Connect LifePort Kidney Transporter Disposable SealRing Cannula, Straight Cannula, or Universal SealRing Cannula to each of the vessels to be perfused according to their Instructions for Use.
3. Identify a main vessel.
4. Place the kidney in the Kidney Cradle and snap the cannula connected to the main vessel into the Cannula Mount.
5. Adjust the height of the Cannula Mount and rotation of the cannula to comfortably position the vessel.
6. Replace the End Cap with one end of the Coupler.
7. Attach the second end of the Coupler to the port of the next cannula.
8. Use an additional Coupler and repeat steps 6 and 7 for each LifePort Kidney Transporter Disposable Cannula being used.
9. Visually inspect the vessels and Coupler tubing, ensuring there are no twists or occlusions.
10. Secure the Mesh Organ Restraint over the kidney in the Kidney Cradle, allowing for slight swelling while being perfused.



**CONSULT INSTRUCTIONS FOR USE:** Follow the procedure in LifePort Kidney Transporter Disposable Perfusion Circuit Instructions for Use on how to place the kidney and Kidney Cradle within LifePort Kidney Transporter Disposable Perfusion Circuit.



**CONSULT INSTRUCTIONS FOR USE:** Follow the procedure outlined in LifePort Kidney Transporter Disposable Sterile Drape Instructions for Use to maintain aseptic conditions.



**CONSULT INSTRUCTIONS FOR USE:** Follow the procedure in LifePort Kidney Transporter Operator's Manual to start the perfusion process and check for leaks and bubbles.

**INTENDED USE**

LifePort Kidney Transporter (LKT) is intended for use in continuous hypothermic machine perfusion of kidneys.

**TARGET POPULATION**

The target populations are patients eligible for kidney transplantation. The licensed kidney transplant surgeon is responsible for assessing patient eligibility to receive kidney transplantation. Patients have no contact with LifePort Kidney Transporter system.

**INTENDED USERS**

Primary users of LifePort Kidney Transporter system are medical professionals who are trained to operate LifePort Kidney Transporter system. It is expected that users of LifePort Kidney Transporter system have a substantive working knowledge and clinical experience with donor organ recovery, perfusion, and transplantation.

**CLINICAL BENEFIT**

Hypothermic machine perfusion of kidneys using LifePort Kidney Transporter system with KPS-1 Kidney Perfusion Solution has been demonstrated through clinical evidence to improve kidney function post transplantation by reducing delayed graft function.

**DEVICE PERFORMANCE/PERFORMANCE CHARACTERISTICS**

LifePort Kidney Transporter system is intended to be used with machine preservation solution to provide continuous hypothermic machine perfusion of kidneys for the preservation, transportation, and eventual transplantation into a recipient. The device maintains the organ in a cool, sterile organ container during perfusion and transport.

**RESIDUAL RISK**

Per the risk management report for LifePort Kidney Transporter, the overall residual risk is acceptable, and the appropriate methods are in place to obtain relevant product and postproduction information.

**SERIOUS INCIDENT REPORTING**

The user should report the occurrence of any serious incident to Organ Recovery Systems and to the competent authority of the Member State in which the user and/or patient is established.

**CONTRAINDICATIONS**

There are no known contraindications when used as directed.

**DEVICE LIFETIME**

LifePort Kidney Transporter Cannulas are single use, disposable devices. The sterile shelf life of an unopened device is 3 years, based on the available test data.





**STORAGE CONDITIONS**

Store between 2°C and 40°C. Avoid excessive heat and humidity. Keep dry and keep away from direct sunlight. Sterile unless package is damaged or open.















**TECHNICAL ASSISTANCE**

Please contact Organ Recovery Systems 24/7 Perfusion Helpline at +866.682.4800 (toll free in US), +32.2.715.0005 (Belgium), +1.352.721.5301 (Central and South America), +33.967.23.00.16 (France), or +49.69677.328.9966 (Germany).

**WARNINGS AND PRECAUTIONS**

- 
- R<sub>Only</sub>** **CAUTION:** Federal (USA) law restricts this device to sale by or on the order of a physician.
- 
-  **CAUTION:** LifePort Kidney Transporter Disposable Products should be stored indoors in a dry location out of direct sunlight.
- 
-  **WARNING:** Visually check LifePort Kidney Transporter Disposable Products. Do not use if parts are loose, cracked, broken, or liquid is leaking.
- 
-  **WARNING:** For single use only. Do not reuse, reprocess, or resterilize. Reusing, reprocessing, or resterilization of single-use devices creates a potential risk of patient or user infections due to contamination. This contamination may lead to injury, illness, or other serious patient complications.
- 
-  **WARNING:** Use standard aseptic technique and universal precautions (e.g., gloves, masks, gowns, goggles or equivalent eye protection, biohazard bags) when handling the kidney, and when handling and disposing of LifePort Kidney Transporter Disposable Products and perfusate to prevent the possible transmission of pathogens to medical personnel and patients. The single practitioner working alone must pay special attention to maintain these conditions.
- 

**EXPLANATION OF SYMBOLS**

	Warning/Caution		Use By, YYYY-MM-DD		Temperature Limits
<b>LOT</b>	Lot Number		Date of Manufacture, YYYY-MM-DD		Consult Instructions for Use
<b>REF</b>	Reference Number		Manufacturer		Keep Away From Sunlight
	Do Not Reuse		Do Not Resterilize		Keep Dry
<b>STERILEEO</b>	Sterile Medical Devices Using Ethylene Oxide	<b>MD</b>	Medical Device	<b>R<sub>Only</sub></b>	Prescription Medical Device
	Country of Origin		Importer		Single Sterile Barrier System
	Do not use if package is damaged and consult instructions for use.				

**AUSTRALIA  
SPONSOR**

**Aurora BioScience Pty Ltd**  
Unit 5C, 256 New Line Road  
Dural, NSW 2158  
Australia



**MedEnvoy Global BV**  
Prinses Margrietplantsoen 33, Suite 123  
2595 AM The Hague  
The Netherlands



**MedEnvoy Switzerland**  
Gotthardstrasse 28  
6302 Zug  
Switzerland



**MedEnvoy Switzerland**  
Gotthardstrasse 28  
6302 Zug  
Switzerland

**UK RESPONSIBLE  
PERSON**

**MedEnvoy UK Limited**  
85, Great Portland Street, First Floor  
London, W1W 7LT  
United Kingdom